

## ANTENNAS | PUCK-3 SERIES

# 3-IN-1 TRANSPORTATION & IOT/M2M ANTENNA

617 – 6000 MHz, 5G (SISO); 2400 – 7200 MHz, Wi-Fi (SISO); GPS/GLONASS



617 – 960 MHz 1427 – 1517 MHz 1710 – 2700 MHz 3400 – 4200 MHz 5000 – 6000 MHz	5G: 5.5 dBi Wi-Fi: 4.5 dBi GPS: 20±3 dBi	GPS Included	Omni-Directional	4G LTE	5G
Machine to Machine	CBRS Band	2.4 – 2.5 GHz 5.0 – 7.2 GHz	IP69K	-40°C to +80°C	Chemical Protection



APPLICATION AREAS

- 3-in-1 5G high performance multi frequency antenna
- Antenna supports 5G/4G/3G/2G/Wi-Fi-7/LoRa/Bluetooth
- 5G (SISO), Wi-Fi (SISO) and GPS/GLONASS
- Ultra-wideband coverage from 617 – 6000 MHz for cellular
- Robust, vandal resistant and waterproof (IP69K)
- Ideal for transportation, marine and IoT/M2M use
- Ultra-versatile mounting options for easy installation

## Product Overview

Poynting's new PUCK range offers a small profile antenna for use in the IoT/M2M, Smart Meter, Smart Utilities, Transportation, Marine, and Agricultural/Farming markets. The PUCK-3 consists of a 3-in-1 antenna system within a single housing, featuring SISO 5G, SISO Wi-Fi, and GPS/GLONASS. The Cellular antenna (for 2G/3G/4G and 5G) offers wideband coverage from 617 to 6000 MHz, covering contemporary LTE/4G and 5G bands for future-proof implementation. The ultra-wideband performance of the cellular antenna allows it to be used across different operators and technologies and is ready for future cellular technologies up to 6 GHz for 5G applications.

The antenna provides a dual-band Wi-Fi antenna offering concurrent 2.4GHz, 5GHz and 6GHz bands, capable of 802.11n and 802.11ac/ax/be. The third antenna is a high-performance active GPS/GLONASS system operating at temperatures as low as -40°C. The PUCK exceeds the performance of many competitors due to the attention to design of this high-performance antenna. The radiation patterns of all radiating elements provide an excellent balance between omnidirectionality, pattern diversity and good radiation abilities at the desired elevation, which is often overlooked in such a small-size antenna. Despite its small size, this antenna provides excellent performance especially at the higher frequency bands, where performance is critical for 5G and LTE throughput and connection stability.

## Features

- Ultra-wideband operation from 617 to 6000 MHz for cellular
- Features 1 x cellular antenna, 1 x Wi-Fi antenna and 1 x GPS antenna
- Small & Low-profile (Ø100mm x h 36mm)
- 5G – includes the 3.4 GHz to 6 GHz CBRS & 5G Bands
- Careful mechanical design provides ruggedness, corrosion, water and dust resistance (IP69K)
- Fire Resistant and UV Stable Enclosure
- Easy installation; multi-implementation options available:
  - Spigot Mount
  - Magnetic Mount
  - Adhesive Surface Mount
  - Wall & Pole Mount

## Application Areas

- Smart utilities: Smart Power, Gas & Water Metering
- Smart Buildings: Climate control, access control, security, irrigation
- Industrial factory automation, robotic machinery and other M2M systems
- Digital Signage
- Warehouses & Logistic systems
- Transport (Busses, Utility & Public Safety)
- Mining Vehicles & Machinery communications, telemetry and automation (M2M & IoT)
- Agricultural machinery
- Marine: small boats, yachts near to coastlines or inner waters



### Frequency Bands

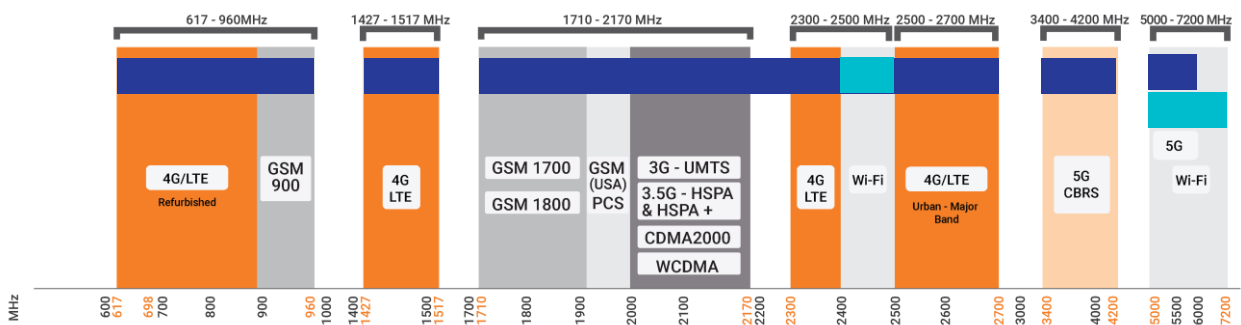

The PUCK-3 is an omni-directional antenna that works from 617 – 960 MHz | 1427 – 1517 MHz | 1710 – 2700 MHz | 3400 – 4200 MHz | 5000 – 6000 MHz | and the following Wi-Fi frequency bands | 2400 – 2500 MHz | and | 5000 – 7200 MHz |



  Indicates the 5G/LTE bands on which PUCK-3 works

  Indicates the WI-FI bands on which PUCK-3 works

**Antenna Overview**

	 LTE	 WiFi DUALBAND	 GPS
<b>Ports</b>	1	2	3
<b>SISO / MIMO</b>	SISO	SISO	N/A
<b>Frequency Bands</b>	617 MHz - 6000 MHz	2.4-2.5 GHz & 5-7.2 GHz	1575.42 MHz/1602 MHz
<b>Peak Gain</b>	5.5 dBi	4.5 dBi	LNA Gain: 20±3 dBi
<b>Coax Cable Type</b>	RTK-031	RTK-031	RTK-031
<b>Coax Cable Length</b>	2m	2m	2m
<b>Connector Type</b>	SMA (M)	SMA (M) (RP-SMA Adapter included)	SMA (M)

*\*The coax cable & connector are factory mounted to the antenna*

**Electrical Specifications - Cellular**

<b>Frequency Bands:</b>	617 – 960 MHz 1427 – 1517 MHz 1710 – 2700 MHz 3400 – 4200 MHz 5000 – 6000 MHz
<b>Gain (Max):</b>	-2 dBi @ 617 - 960 MHz 2 dBi @ 1427 - 1527 MHz 4.5 dBi @ 1710 - 2700 MHz 5.5 dBi @ 3400 - 4200 MHz 5 dBi @ 5000 – 6000 MHz
<b>VSWR:</b>	≤2.5:1 Across 90% of the bands
<b>Feed Power Handling:</b>	10 W
<b>Input Impedance:</b>	50 Ohm (nominal)
<b>Polarisation:</b>	Linear Vertical
<b>Coax Cable Loss:</b>	0.56 dB/m @ 900 MHz 0.785 dB/m @ 1800 MHz 1.2 dB/m @ 3000 MHz
<b>DC Short:</b>	Yes

**Electrical Specifications - GPS/Glonass Antenna**

<b>Frequency Range (GPS):</b>	1575.42MHz/1602MHz
<b>LNA Gain (Max):</b>	20±3 dBi
<b>VSWR:</b>	≤2
<b>Voltage:</b>	2.7-5 V
<b>Working Current:</b>	≤20mA
<b>Noise Figure:</b>	≤2 dB
<b>Nominal Impedance:</b>	50 Ω
<b>Polarisation:</b>	RHCP
<b>Power Handling:</b>	33dBm
<b>Coax cable loss:</b>	0.71 dB/m @ 1500 MHz

**Electrical Specifications – Wi-Fi**

<b>Frequency:</b>	2400-2500 MHz 5000–7200 MHz
<b>Gain (Max):</b>	2 dBi @ 2400-2500 MHz 4.5 dBi @ 5000–7200 MHz
<b>VSWR:</b>	<2:1
<b>Feed power handling:</b>	10 W
<b>Nominal input impedance:</b>	50 Ohm (nominal)
<b>Polarisation:</b>	Linear Vertical
<b>Coax Cable Loss:</b>	0.91 dB/m @ 2400 MHz 1.65 dB/m @ 5800 MHz
<b>Path to Ground:</b>	Yes

**Product Box Contents**

<b>Antenna:</b>	A-PUCK-0003-V2-01
<b>Mounting Bracket:</b>	Ø20 Threaded Spigots (Up to 60mm clamping thickness), Adhesive Surface Mounting & Magnetic Mount
<b>Adapters:</b>	1x RP-SMA(M) To SMA (F)

**Ordering Information**

<b>Commercial Name:</b>	PUCK-3
<b>Order Product Code:</b>	A-PUCK-0003-V2-01
<b>EAN Number:</b>	6009710928271
<b>E-Mark Certification Number:</b>	E1*10R06/01*9551*00

**Mechanical Specifications**

<b>Product Dimensions</b>	Ø99.3 mm x 36 mm
<b>Packaged Dimensions:</b>	150 mm x 150mm x 120mm
<b>Weight:</b>	0.426kg
<b>Packaged Weight:</b>	0.603kg
<b>Radome Material:</b>	PC+ABS (Halogen free)
<b>Radome Colour:</b>	Black
<b>Mounting Type:</b>	Ø20 Threaded Spigot, Pole, Wall, Surface and Magnetic mount

**Environmental Specifications, Certification & Approvals**

<b>Wind Survival:</b>	≤220 km/h
<b>Temperature Range (Operating):</b>	-40°C to +80°C
<b>Environmental Conditions:</b>	Outdoor/Indoor
<b>Water Ingress Protection Ratio/Standard:</b>	IP69K
<b>Salt Spray:</b>	MIL-STD 810G/ASTM B117
<b>Operating Relative Humidity:</b>	Up to 98%
<b>Storage Humidity:</b>	5% to 95% - non-condensing
<b>Storage Temperature:</b>	-40°C to +80°C
<b>Enclosure Flammability Rating:</b>	UL 94-HB
<b>Impact Resistance:</b>	IK 10
<b>Product Safety &amp; Environmental:</b>	Complies with CE and RoHS standards



**Antenna Performance Plots**

**VSWR: Cellular Antenna**

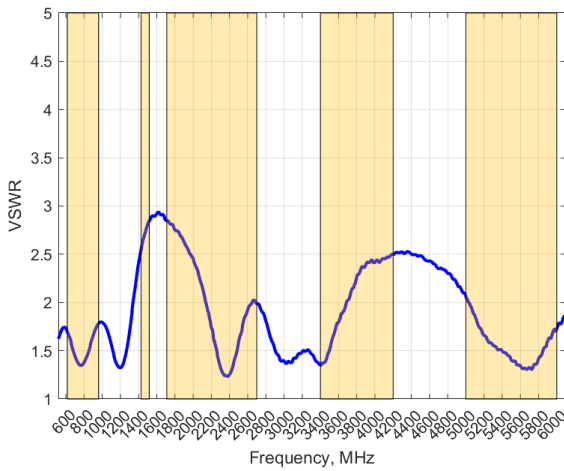

**Voltage Standing Wave Ratio (VSWR)\***

VSWR is a measure of how efficiently radio-frequency power is transmitted from a power source, through a transmission line, into a load. In an ideal system, 100% of the energy is transmitted which corresponds to a VSWR of 1:1.

The PUCK-3 delivers superior performance across all bands with a VSWR of  $\leq 2.5:1$  across 90% of the bands.

*\*Measured with 2m low loss cable, 650 x 650 mm ground plane, and unused ports terminated with 50Ω load*

**GAIN (Excluding Cable Loss): Cellular Antenna**

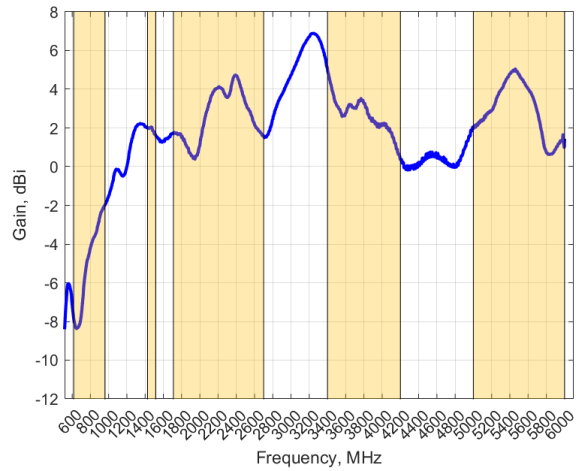

**Gain\* in dBi**

5.5 dBi is the peak gain across all bands from 617 – 6000 MHz

Gain @ 617 – 960 MHz:	-2 dBi
Gain @ 1427 – 1517 MHz:	2 dBi
Gain @ 1710 – 2700 MHz:	4.5 dBi
Gain @ 3400 – 4200 MHz:	5.5 dBi
Gain @ 5000 – 6000 MHz:	5 dBi

*\*Antenna gain measured with polarisation aligned standard antenna*

**VSWR: Wi-Fi Antenna**

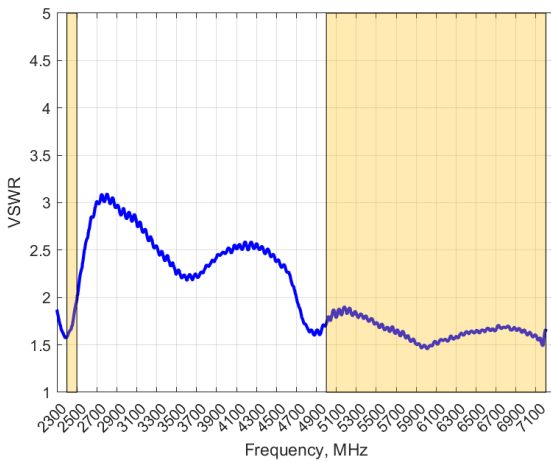

**Voltage Standing Wave Ratio (VSWR)\***

VSWR is a measure of how efficiently radio-frequency power is transmitted from a power source, through a transmission line, into a load. In an ideal system, 100% of the energy is transmitted which corresponds to a VSWR of 1:1.

The PUCK-3 delivers superior performance across all bands with a VSWR of  $< 2:1$ .

*\*Measured with 2m low loss cable, 650 x 650 mm ground plane, and unused ports terminated with 50Ω load.*

**GAIN (Excluding Cable Loss): Wi-Fi Antenna**

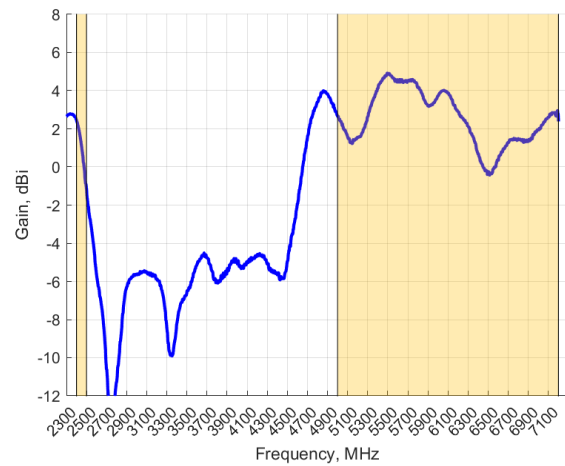

**Gain\* in dBi**

4.5 dBi is the peak gain across all bands from 2400 – 2500 MHz & 5000 – 7200 MHz

Gain @ 2400 – 2500 MHz:	2 dBi
Gain @ 5000 – 7200 MHz:	4.5 dBi

*\*Antenna gain measured with polarisation aligned standard antenna*

**Radiation Patterns – Cellular**

**Azimuth: 617 – 968 MHz**

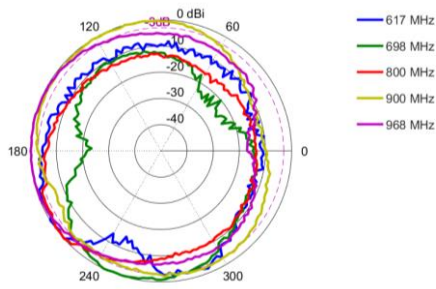

**Elevation: 617 – 968 MHz**

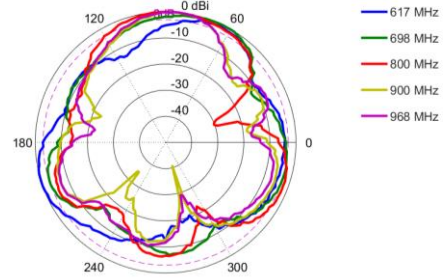

**Azimuth: 1427 – 1517 MHz**

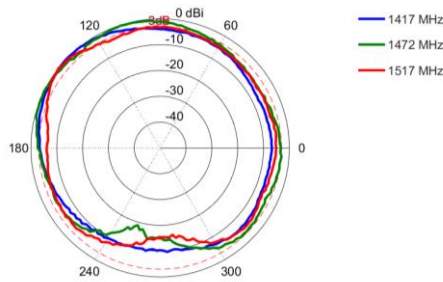

**Elevation: 1427 – 1517 MHz**

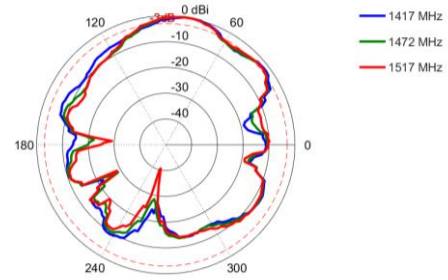

**Azimuth: 1710 – 2170 MHz**

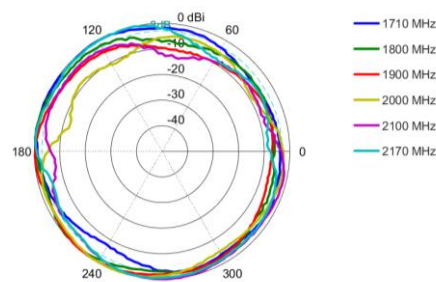

**Elevation: 1710 – 2100 MHz**

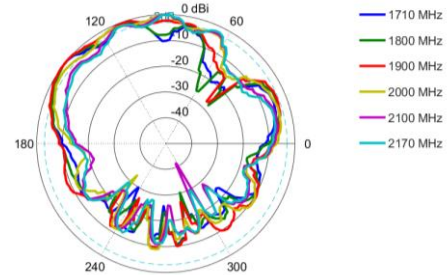

**Azimuth: 2300 – 2700 MHz**

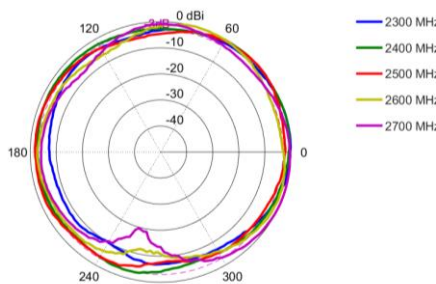

**Elevation: 2300 – 2700 MHz**

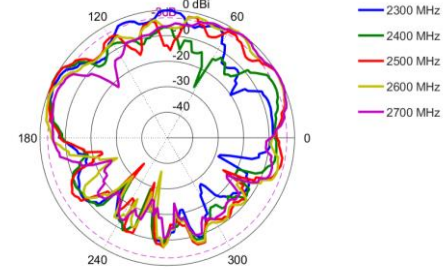

**Azimuth: 3400 – 3800 MHz**

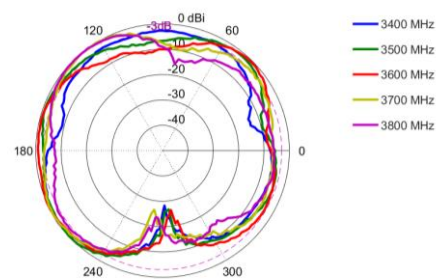

**Elevation: 3400 – 3800 MHz**

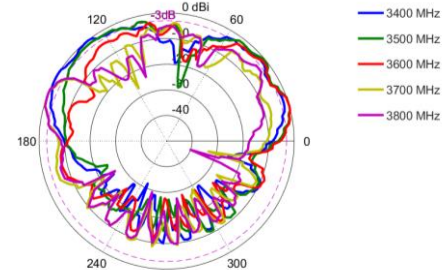

**Azimuth: 4000 – 4200 MHz**

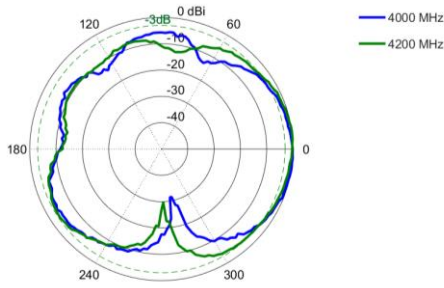

**Elevation: 4000 – 4200 MHz**

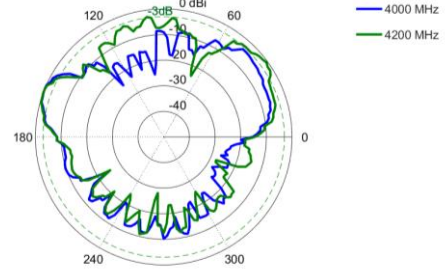

**Azimuth: 5000 – 5400 MHz**

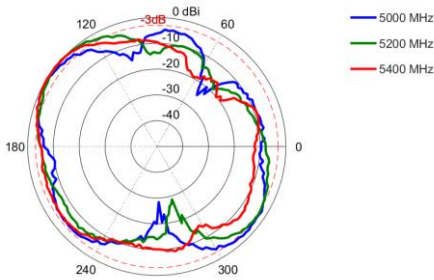

**Elevation: 5000 – 5400 MHz**

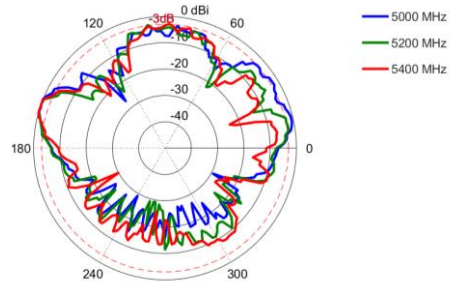

**Azimuth: 5600 – 6000 MHz**

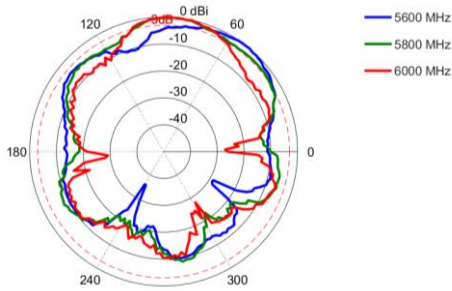

**Elevation: 5600 – 6000 MHz**

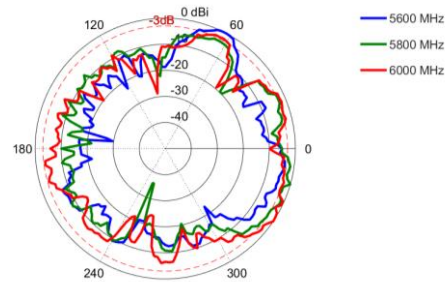

**Radiation Patterns – Wi-Fi**

**Azimuth: 2400 – 2500 MHz**

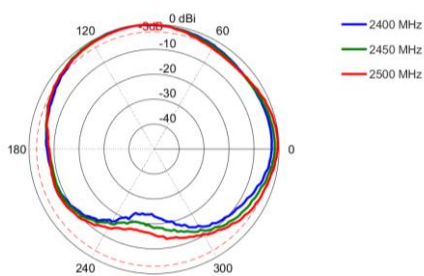

**Elevation: 2400 – 2500 MHz**

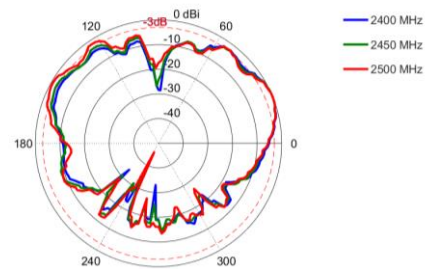

**Azimuth: 5000 – 5400 MHz**

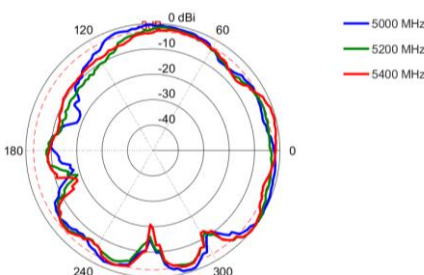

**Elevation: 5000 – 5400 MHz**

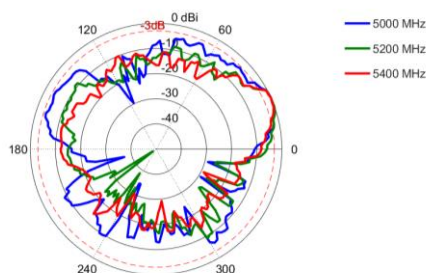

**Azimuth: 5600 – 5800 MHz**

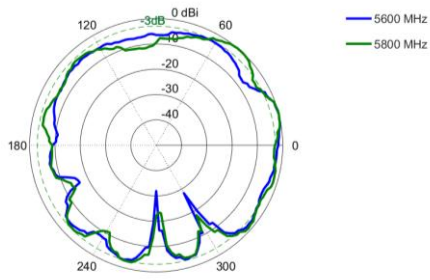

**Elevation: 5600 – 5800 MHz**

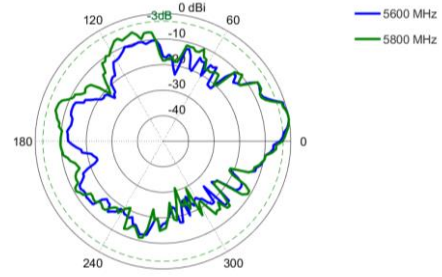

**Azimuth: 6000 – 7200 MHz**

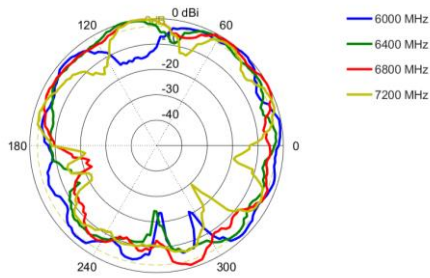

**Elevation: 6000 – 7200 MHz**

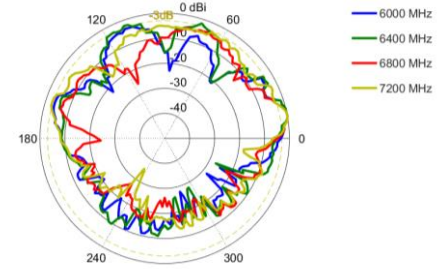

**Technical Drawings**

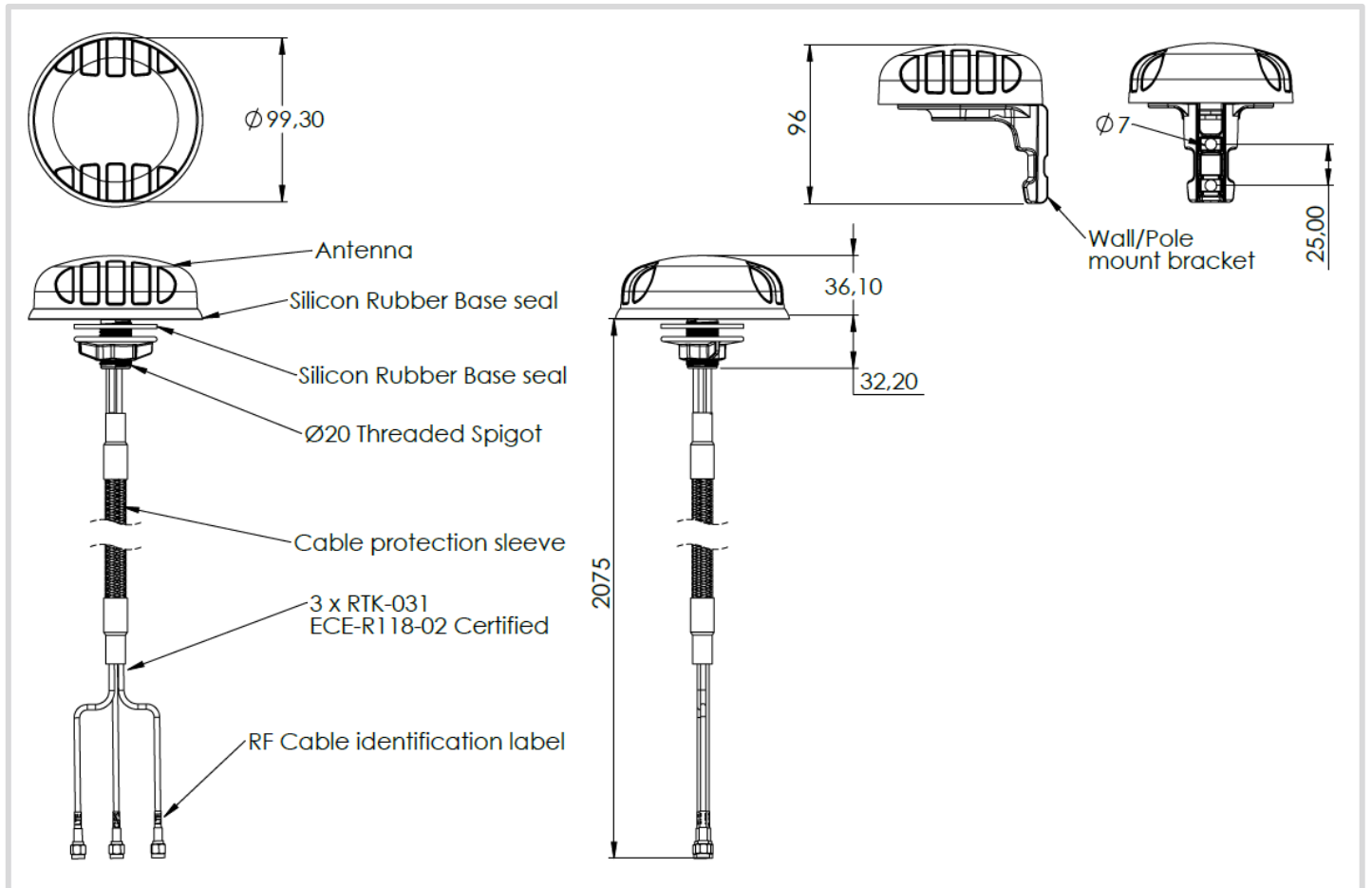



## Mounting Options

### Many Mounting Possibilities – included as standard

Poynting's new PUCK antenna range provides easy installation with the multiple mounting options. This includes as standard:

- Spigot Mount - two different lengths included (35mm & 75mm)
- Vertical Pole mount (inner & outer mounting for smaller and larger poles)
- Horizontal Pole Mount (e.g., marine rails)
- Magnetic Mount
- Surface Mount (Double Sided Tape)
- Wall Mount

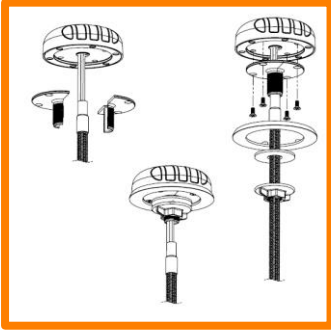

#### Spigot Mount

Removable 35mm & 75mm threaded spigot (included)

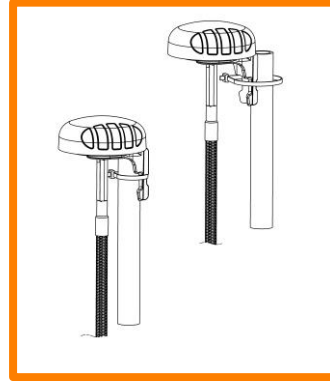

#### Vertical Pole Mount

Pole/Wall Mounting bracket (included)

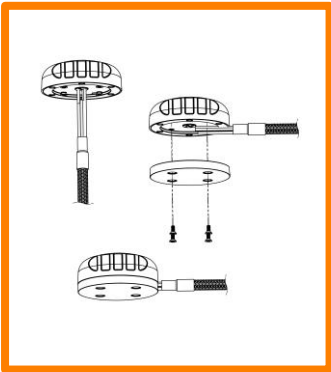

#### Magnetic Mount

Magnetic Base (included)  
For temporary and low mobility installations.

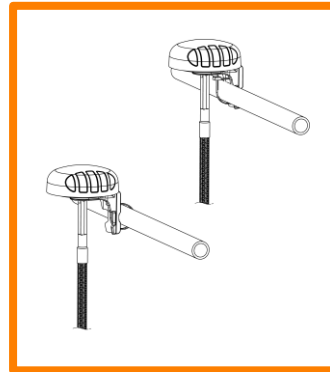

#### Horizontal Pole Mount

Pole/Wall Mounting bracket (included)

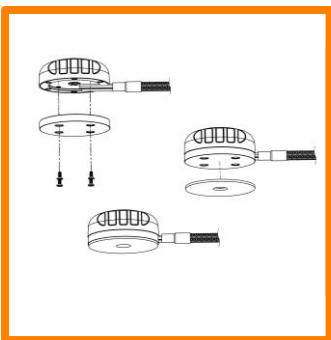

#### Surface Mount

Adhesive Surface Mounting (included) or can also be directly secured with longer M4 bolts (not included) to the female threaded inserts located in the antenna base

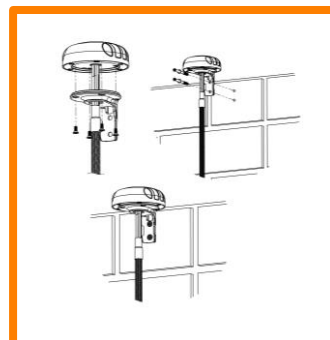

#### Wall Mount

Pole/Wall Mounting bracket (included)

---

## Additional Accessories

See accessories technical specifications on [www.poynting.tech](http://www.poynting.tech)



---

## CONTACT POYNTING

### Poynting Antennas (Pty) Ltd - Head Office

Unit 4, N1 Industrial Park,  
Landmarks Avenue,  
Samrand, 0157, South Africa

**Phone:** +27 (0) 12 657 0050

**E-mail:** [info@poynting.tech](mailto:info@poynting.tech)

**International Email:** [sales-global@poynting.tech](mailto:sales-global@poynting.tech)

### Poynting Europe

Regus Business Center Neue Messe Riem  
Kronstadter Straße 4  
81677 München  
Germany

**Phone:** +49 89 7453 9002

**E-mail:** [sales-europe@poynting.tech](mailto:sales-europe@poynting.tech)

### Poynting USA

1804 Owen Court, Suite 104,  
Mansfield,  
TX 76063  
USA

**Phone:** +1 817 533-8130

**E-mail:** [sales-us@poynting.tech](mailto:sales-us@poynting.tech)