



ANTENNAS | PUCK-7 SERIES

4-IN-1 TRANSPORTATION & IOT/M2M ANTENNA

617 – 6000 MHz, 2x2 5G (MIMO), 6.5 dBi; 2400 – 7200 MHz, 2x2 Wi-Fi (MIMO), 6 dBi



					
617 – 960 MHz 1427 – 1517 MHz 1710 – 2700 MHz 3400 – 4200 MHz 5000 – 6000 MHz	5G: 6.5 dBi Wi-Fi: 6 dBi	2.4 – 2.5 GHz 5.0 – 7.2 GHz	Omni-Directional	4G LTE	5G
					
Machine to Machine	CBRS Band	2X2 MIMO	IP69K	-40°C to +80°C	Fire Resistant



APPLICATION AREAS

- 4-in-1 5G high performance multi frequency antenna
- Antenna supports Private 5G/5G/4G/3G/2G/Wi-Fi-6e/Wi-Fi-7/LoRa/Bluetooth
- 5G (2x2 MIMO) and Dual-band Wi-Fi (2x2 MIMO)
- Ultra-wideband coverage from 617 – 6000 MHz for cellular
- Robust, vandal resistant and waterproof (IP69K)
- Ideal for transportation, marine and IoT/M2M use
- Ultra-versatile mounting options for easy installation

Product Overview

Poynting's new PUCK range offers a small profile antenna for use in the IoT/M2M, Smart Meter, Smart Utilities, Transportation, Marine, and Agricultural/Farming markets. The PUCK-7 consists of a 4-in-1 antenna system within a single housing, featuring 2x2 MIMO 5G and 2x2 MIMO Wi-Fi (Dual-band 2.4GHz & 5GHz) The 2x Cellular MIMO antennas (for 2G/3G/4G and 5G) offer wideband coverage from 617 to 6000 MHz, covering contemporary LTE/4G and 5G bands for future-proof implementation. The ultra-wideband performance of the cellular antennas allows it to be used across different operators and technologies and is ready for future cellular technologies up to 6 GHz for 5G applications.

The antenna provides two separate dual-band Wi-Fi antennas offering concurrent 2.4GHz, 5GHz, and 6GHz bands, capable of 802.11n and 802.11ac/ax/be with 2x2 MIMO. The PUCK exceeds many competitors' performance due to the attention to the design of this high-performance antenna. The radiation patterns of all radiating elements provide an excellent balance between omnidirectionality, pattern diversity, and good radiation abilities at the desired elevation, which is often overlooked in such a small antenna. Despite its small size, this antenna provides excellent performance especially at the higher frequency bands, where performance is critical for 5G and LTE throughput and connection stability. This antenna is designed so that both the 5G/LTE ports are connected to the router/device to ensure the best performance. Please see other derivatives of the PUCK range that are more suitable for a SISO application.

Features

- Ultra-wideband operation from 617 to 6000 MHz for cellular
- Features 2 x cellular antennas and 2 x Wi-Fi antennas
- 5G – includes the 3.4 GHz to 6 GHz CBRS & 5G Bands
- Small & Low-profile (Ø100mm x h 36mm)
- Careful mechanical design provides ruggedness, corrosion, water and dust resistance (IP69K)
- Fire Resistant, UV Stable Enclosure
- Easy installation; multi-implementation options available:
 - Spigot Mount
 - Magnetic Mount
 - Adhesive Surface Mount
 - Wall & Pole Mount

Application Areas

- Smart utilities: Smart power, Gas & Water Metering
- Smart Buildings: Climate control, access control, security, irrigation
- Industrial factory automation, robotic machinery and other M2M systems
- Digital Signage
- Warehouses & Logistic systems
- Transport (Busses, Utility & Public Safety)
- Mining Vehicles & Machinery communications, telemetry and automation (M2M & IoT)
- Agricultural machinery
- Marine: small boats, yachts near to coastlines or inner waters



Frequency Bands

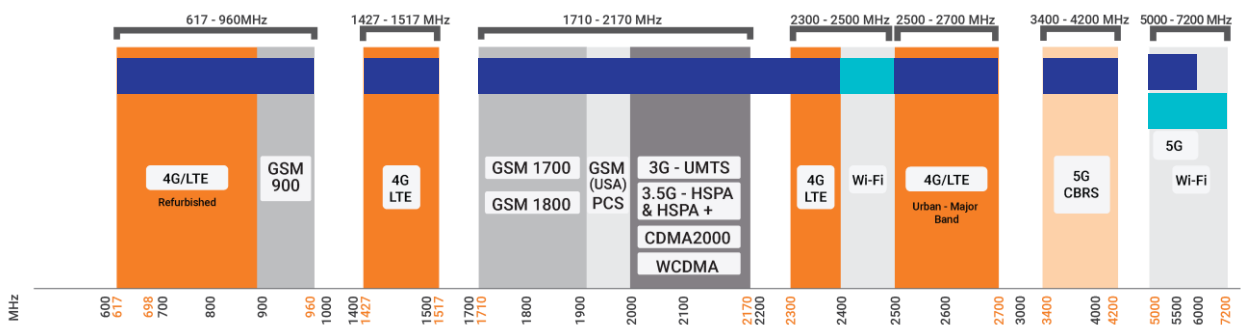

The PUCK-7 is an omni-directional antenna that works from 617 – 960 MHz | 1427 – 1517 MHz | 1710 – 2700 MHz | 3400 – 4200 MHz | 5000 – 6000 MHz | and the following Wi-Fi frequency bands | 2400 – 2500 MHz | and | 5000 – 7200 MHz |



Indicates the 5G/LTE bands on which PUCK-7 works

Indicates the WI-FI bands on which PUCK-7 works

Antenna Overview

	 LTE	 WiFi DUALBAND
Ports	1 & 2	3 & 4
SISO / MIMO	2x2 MIMO	2x2 MIMO
Frequency Bands	617 MHz - 6000 MHz	2.4 - 2.5 & 5-7.2 GHz
Peak Gain	6.5 dBi	6 dBi
Coax Cable Type	RTK-031	RTK-031
Coax Cable Length	2m	2m
Connector Type	SMA (M)	SMA (M) (RP-SMA Adapter included)

**The coax cable & connector are factory mounted to the antenna*

Electrical Specifications - Cellular

Frequency Bands:	617 – 960 MHz 1427 – 1517 MHz 1710 – 2700 MHz 3400 – 4200 MHz 5000 – 6000 MHz
Gain (Max) Port 1 & 2:	0 dBi @ 617 - 960 MHz 1 dBi @ 1427 - 1527 MHz 5 dBi @ 1710 - 2700 MHz 4.5 dBi @ 3400 - 4200 MHz 6.5 dBi @ 5000 – 6000 MHz
VSWR Port 1 & 2:	<2.5:1
Feed Power Handling:	10 W
Input Impedance:	50 Ohm (nominal)
Polarisation:	Linear Vertical
Coax Cable Loss:	0.56 dB/m @ 900 MHz 0.71 dB/m @ 1500 MHz 0.785 dB/m @ 1800 MHz 1.2 dB/m @ 3000 MHz
DC Short:	Yes

Electrical Specifications – Wi-Fi

Frequency:	2400 - 2500 MHz 5000 – 7200 MHz
Gain (Max) Port 1 & 2:	4dBi @ 2400-2500 MHz 6dBi @ 5000–7200 MHz
VSWR Port 1 & 2:	<2:1
Feed power handling:	10 W
Nominal input impedance:	50 Ohm (nominal)
Polarisation:	Linear Vertical
Coax Cable Loss:	0.91 dB/m @ 2400 MHz 1.65 dB/m @ 5800 MHz
Path to Ground:	Yes

Product Box Contents

Antenna:	A-PUCK-0007-V2-01
Mounting Bracket:	Ø20 Threaded Spigots (Up to 60mm clamping thickness), Adhesive Surface Mounting & Magnetic Mount
Adapters:	2x RP-SMA(M) To SMA (F)

Ordering Information

Commercial name:	PUCK-7
Order product code:	A-PUCK-0007-V2-01
EAN number:	6009710928318
E-Mark Certification Number:	E1*10R06/01*9551*00

Mechanical Specifications

Product Dimensions	Ø99.3 mm x 36 mm
Packaged Dimensions:	150 mm x 150mm x 120mm
Weight:	0.34kg
Packaged Weight:	0.661kg
Radome material:	PC+ABS (Halogen free)
Radome colour:	Black
Mounting Type:	Ø20 Threaded Spigot, Pole, Wall, Surface and Magnetic mount

Environmental Specifications, Certification & Approvals

Wind Survival:	≤220 km/h
Temperature Range (Operating):	-40°C to +80°C
Environmental Conditions:	Outdoor/Indoor
Water Ingress Protection Ratio/Standard:	IP69K
Salt Spray:	MIL-STD 810G/ASTM B117
Operating Relative Humidity:	Up to 98%
Storage Humidity:	5% to 95% - non-condensing
Storage Temperature:	-40°C to +80°C
Enclosure Flammability Rating:	UL 94-HB
Impact Resistance:	IK 10
Product Safety & Environmental:	Complies with CE and RoHS standards

Antenna Performance Plots

VSWR: Cellular Antenna

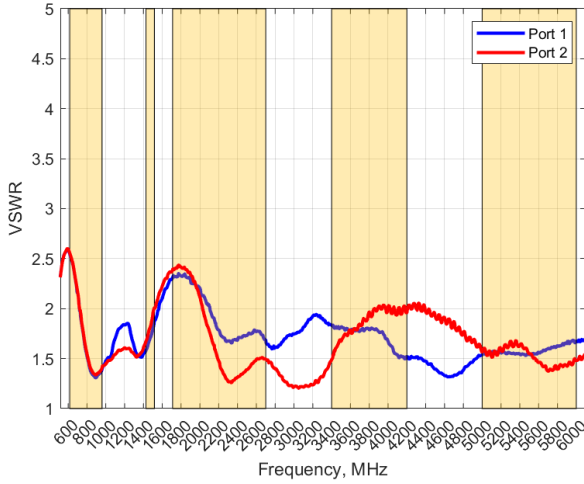

GAIN (Excluding Cable Loss): Cellular Antenna

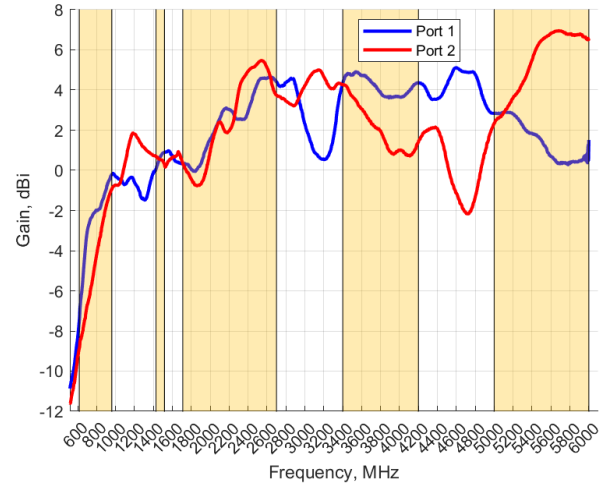

Voltage Standing Wave Ratio (VSWR)*

VSWR is a measure of how efficiently radio-frequency power is transmitted from a power source, through a transmission line, into a load. In an ideal system, 100% of the energy is transmitted which corresponds to a VSWR of 1:1.

The PUCK-7 delivers superior performance across all bands with a VSWR of <2.5:1.

**Measured with 2m low loss cable, 650 x 650 mm ground plane, and unused ports terminated with 50Ω load*

Gain* in dBi

6.5 dBi is the peak gain across all bands from 617 – 6000 MHz

Gain @ 617 - 960 MHz:	0 dBi
Gain @ 1427 - 1517 MHz:	1 dBi
Gain @ 1710 – 2700 MHz:	5 dBi
Gain @ 3400 – 4200 MHz:	4.5 dBi
Gain @ 5000 – 6000 MHz:	6.5 dBi

**Antenna gain measured with polarisation aligned standard antenna*

VSWR: Wi-Fi Antenna

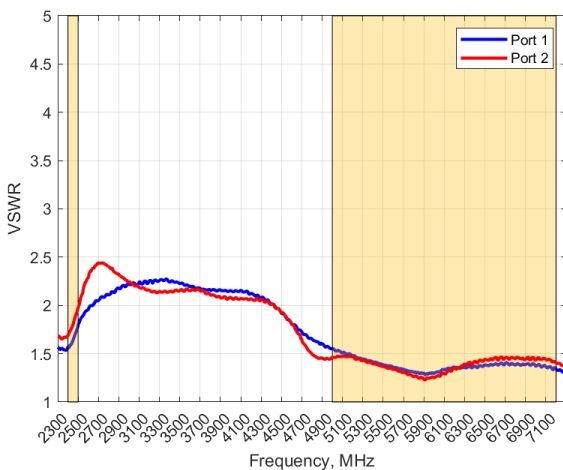

GAIN (Excluding Cable Loss): Wi-Fi Antenna

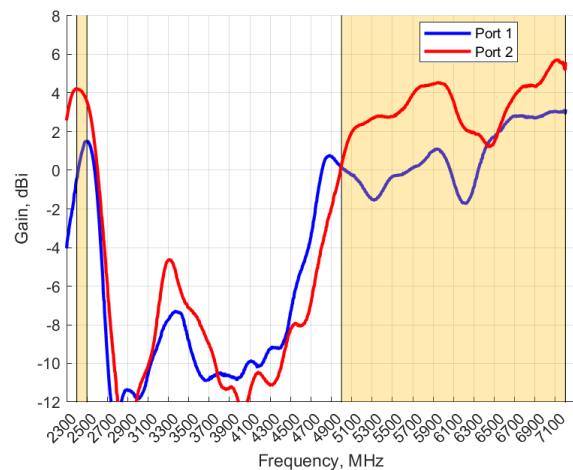

Voltage Standing Wave Ratio (VSWR)*

VSWR is a measure of how efficiently radio-frequency power is transmitted from a power source, through a transmission line, into a load. In an ideal system, 100% of the energy is transmitted which corresponds to a VSWR of 1:1.

The PUCK-7 delivers superior performance across all bands with a VSWR of <2:1.

**Measured with 2m low loss cable, 650 x 650 mm ground plane, and unused ports terminated with 50Ω load.*

Gain* in dBi

6 dBi is the peak gain across all bands from 2400 – 2500 MHz & 5000 – 7200 MHz

Gain @ 2400 – 2500 MHz:	4 dBi
Gain @ 5000 – 7200 MHz:	6 dBi

**Antenna gain measured with polarisation aligned standard antenna*

Radiation Patterns – Cellular

Azimuth: 617 – 960 MHz

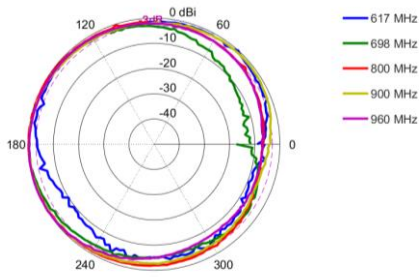

Elevation 1: 617 – 960 MHz

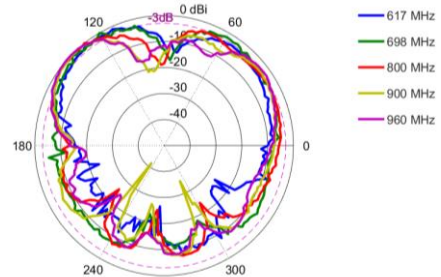

Elevation 2: 617 – 968 MHz

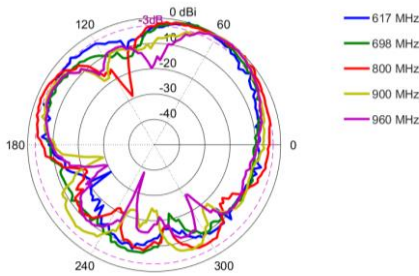

Azimuth: 1427 – 1517 MHz

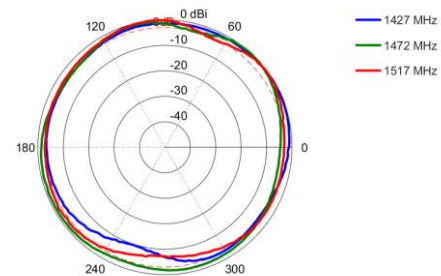

Elevation 1: 1427 – 1517 MHz

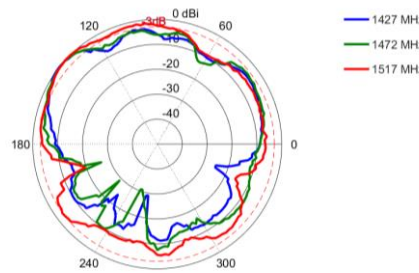

Elevation 2: 1427 – 1517 MHz

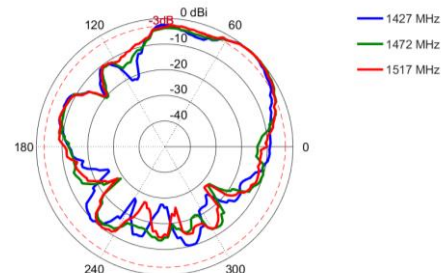

Azimuth: 1710 – 2170 MHz

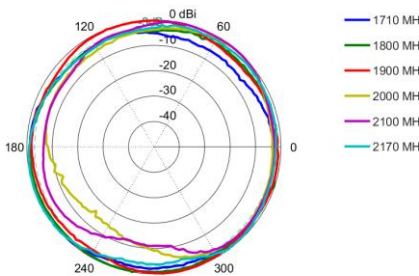

Elevation 1: 1710 – 2170 MHz

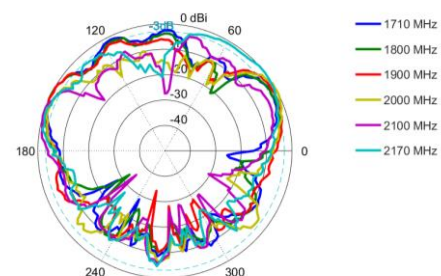

Elevation 2: 1710 – 2170 MHz

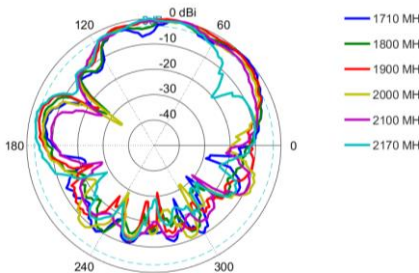

Azimuth: 2300 – 2700 MHz

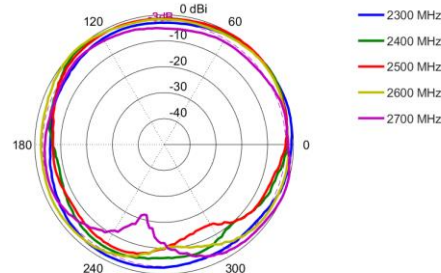

Elevation 1: 2300 – 2700 MHz

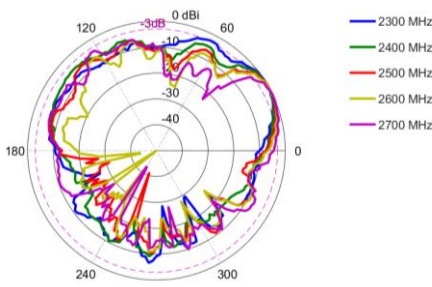

Elevation 2: 2300 – 2700 MHz

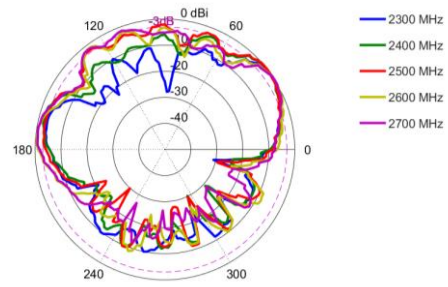

Azimuth: 3400 – 3800 MHz

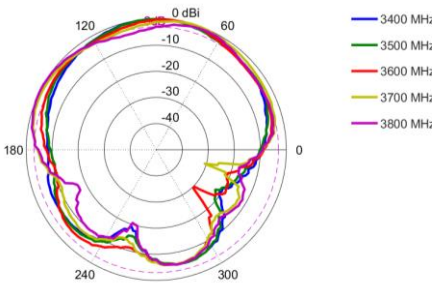

Elevation 1: 3400 – 3800 MHz

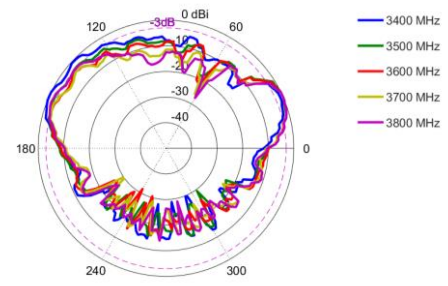

Elevation 2: 3400 – 3800 MHz

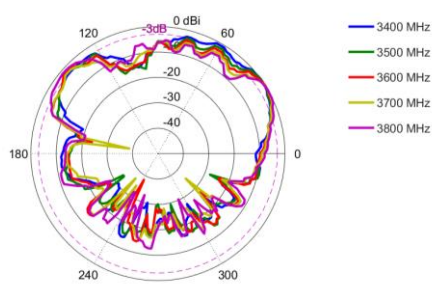

Azimuth: 4000 – 4200 MHz

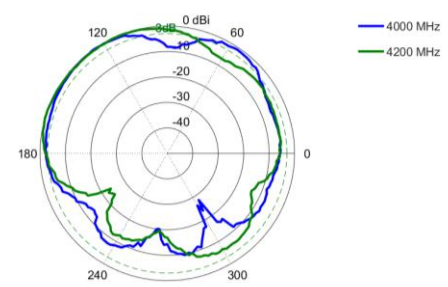

Elevation 1: 4000 – 4200 MHz

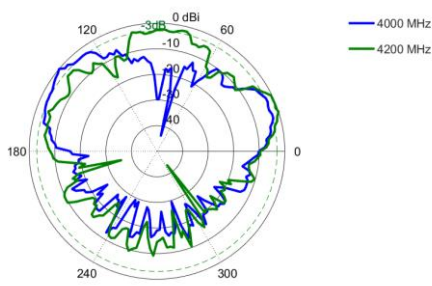

Elevation 2: 4000 – 4200 MHz

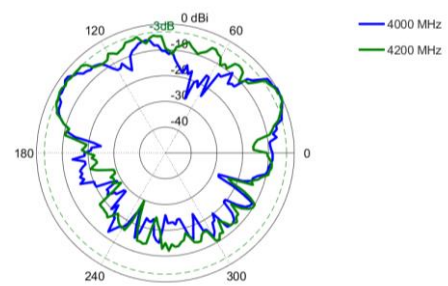

Azimuth: 5000 – 5400 MHz

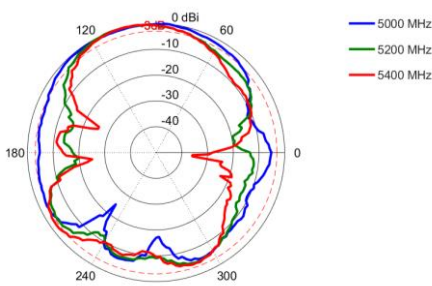

Elevation 1: 5000 – 5400 MHz

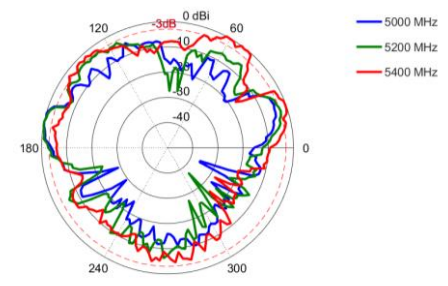

Elevation 2: 5000 – 5400 MHz

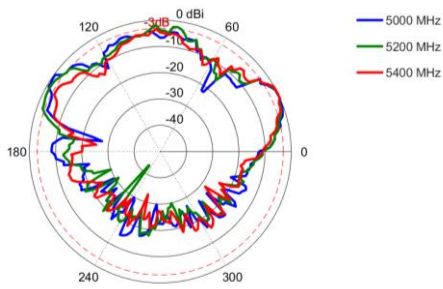

Azimuth: 5600 – 6000 MHz

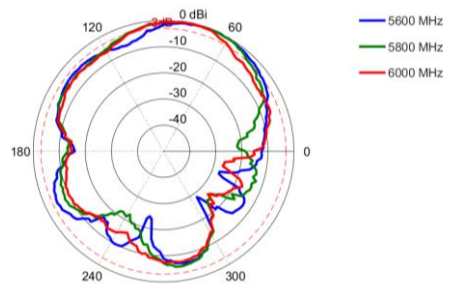

Elevation 1: 5600 – 6000 MHz

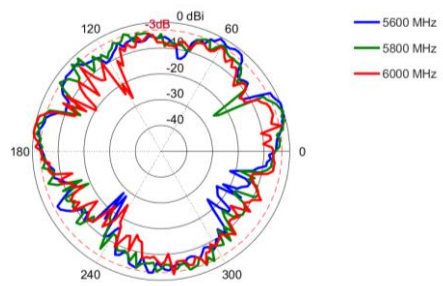

Elevation 2: 5600 – 6000 MHz

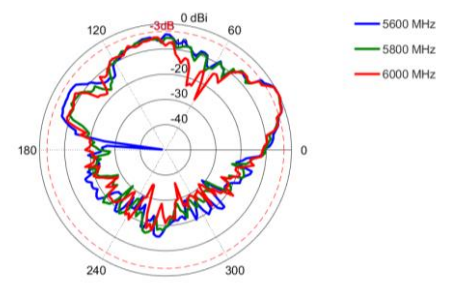

Radiation Patterns – Wi-Fi

Azimuth: 2400 – 2500 MHz

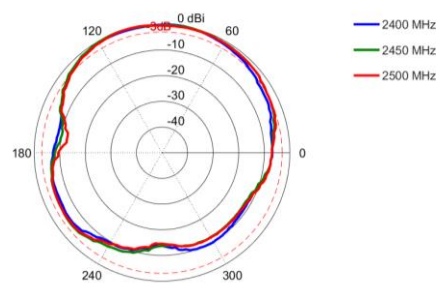

Elevation 1: 2400 – 2500 MHz

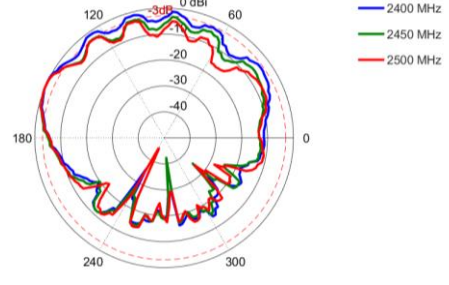

Elevation 2: 2400 – 2500 MHz

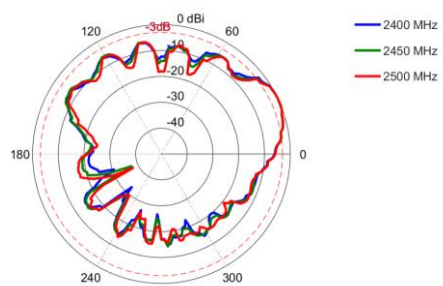

Azimuth: 5000 – 5400 MHz

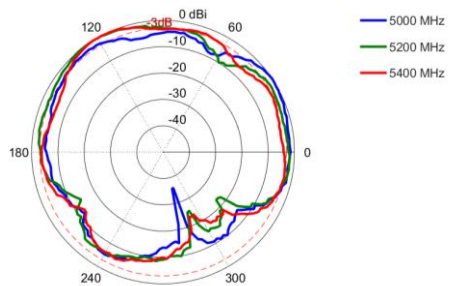

Elevation 1: 5000 – 5400 MHz

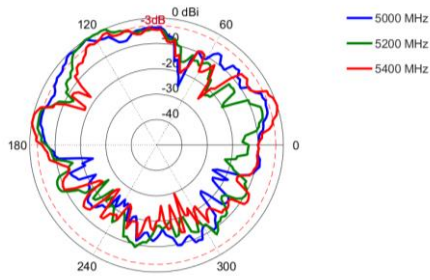

Elevation 2: 5000 – 5400 MHz

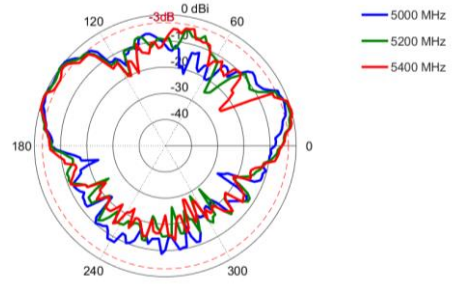

Azimuth: 5600 – 5800 MHz

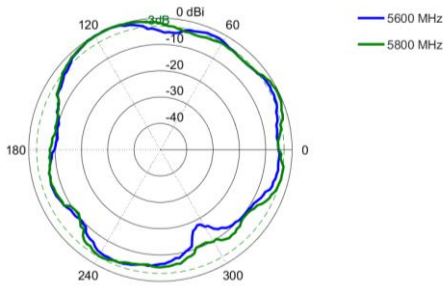

Elevation 1: 5600 – 5800 MHz

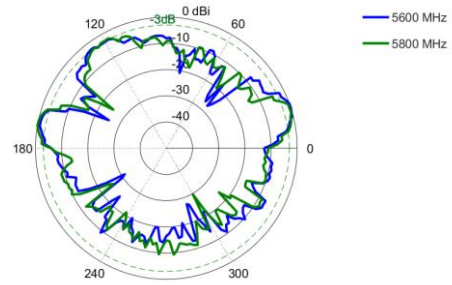

Elevation 2: 5600 – 5800 MHz

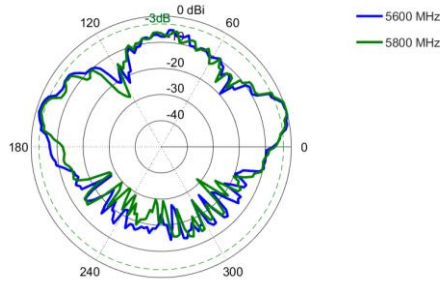

Azimuth: 6000 – 7200 MHz

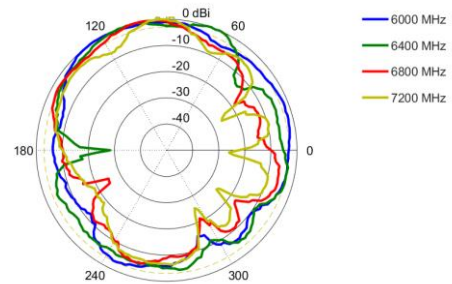

Elevation 1: 6000 – 7200 MHz

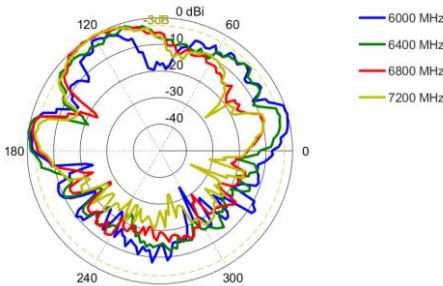

Elevation 2: 6000 – 7200 MHz

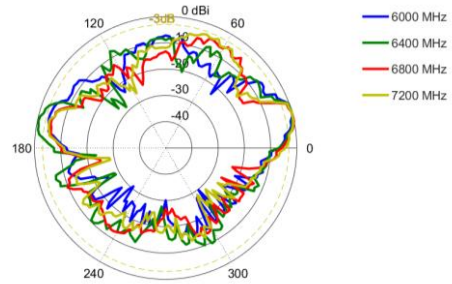

Technical Drawings

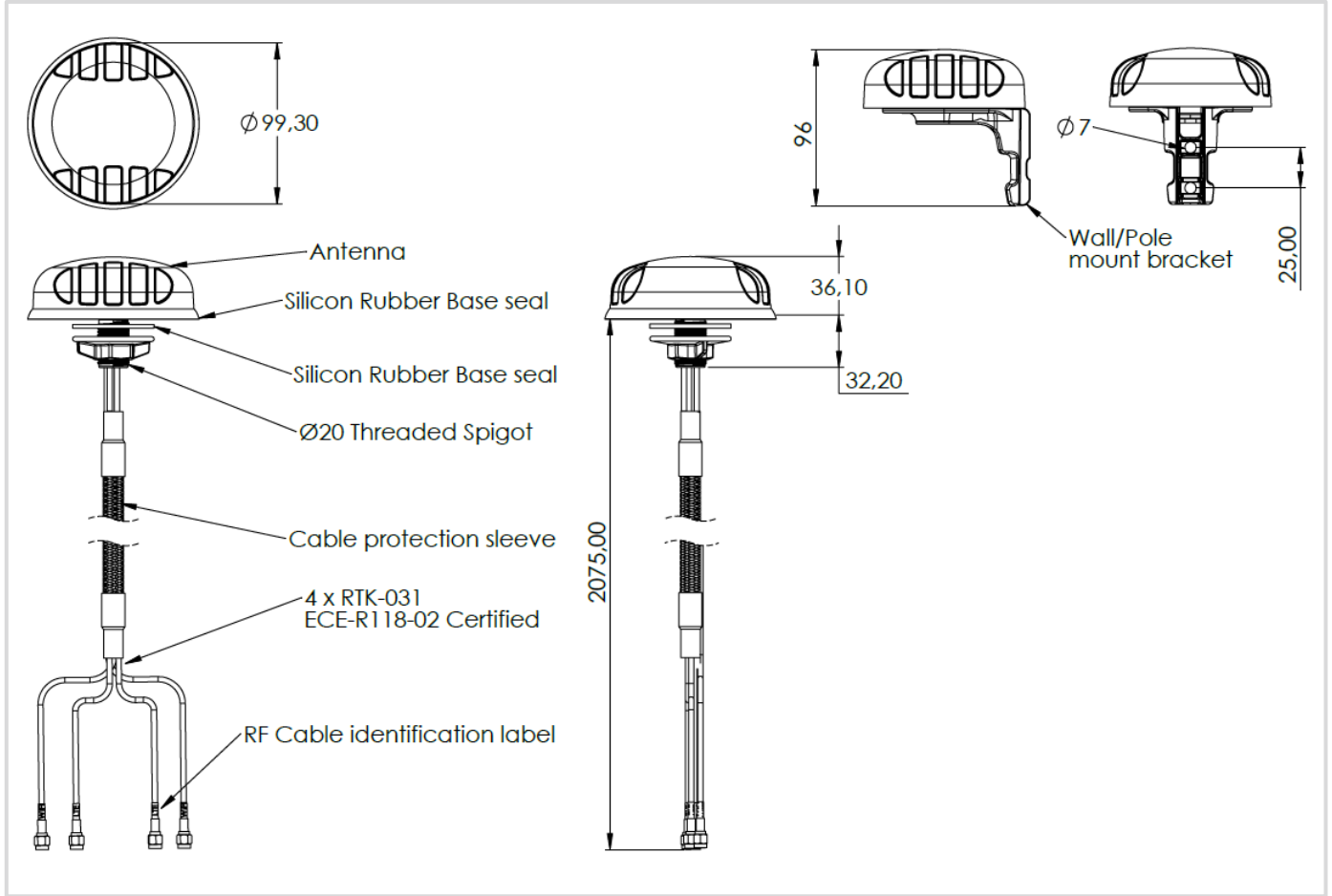

Mounting Options

Many Mounting Possibilities – included as standard

Poynting's new PUCK antenna range provides easy installation with the multiple mounting options. This includes as standard:

- Spigot Mount - two different lengths included (35mm & 75mm)
- Vertical Pole mount (inner & outer mounting for smaller and larger poles)
- Horizontal Pole Mount (e.g., marine rails)
- Magnetic Mount
- Surface Mount (Double Sided Tape)
- Wall Mount

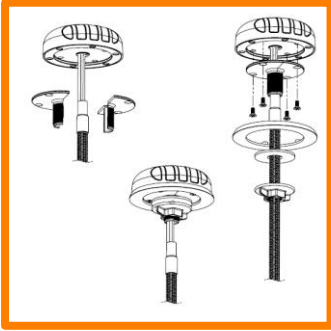

Spigot Mount

Removable 35mm & 75mm threaded spigot (included)

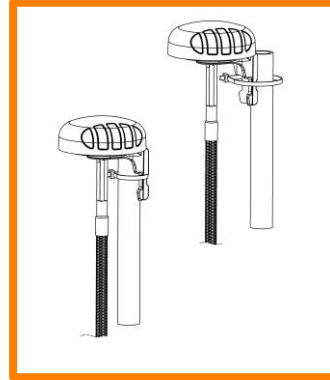

Vertical Pole Mount

Pole/Wall Mounting bracket (included)

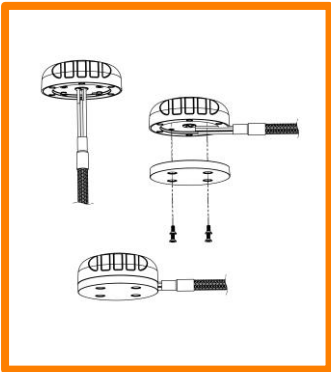

Magnetic Mount

Magnetic Base (included)
For temporary and low mobility installations.

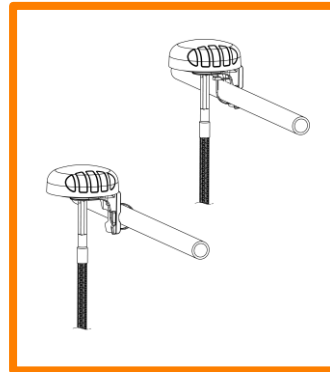

Horizontal Pole Mount

Pole/Wall Mounting bracket (included)

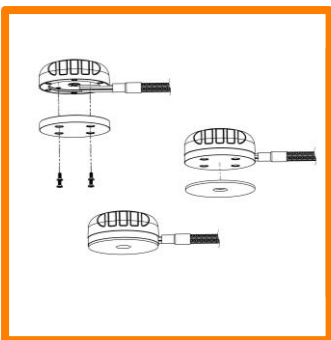

Surface Mount

Adhesive Surface Mounting (included) or can also be directly secured with longer M4 bolts (not included) to the female threaded inserts located in the antenna base

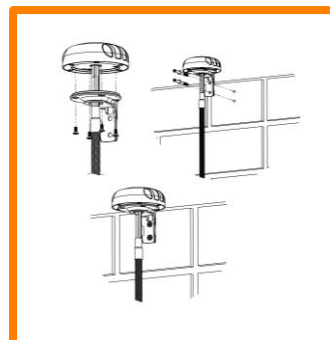

Wall Mount

Pole/Wall Mounting bracket (included)

Additional Accessories

See accessories technical specifications on www.poynting.tech



CONTACT POYNTING

Poynting Antennas (Pty) Ltd - Head Office

Unit 4, N1 Industrial Park,
Landmarks Avenue,
Samrand, 0157, South Africa

Phone: +27 (0) 12 657 0050

E-mail: info@poynting.tech

International Email: sales-global@poynting.tech

Poynting Europe

Regus Business Center Neue Messe Riem
Kronstadter Straße 4
81677 München
Germany

Phone: +49 89 7453 9002

E-mail: sales-europe@poynting.tech

Poynting USA

1804 Owen Court, Suite 104,
Mansfield,
TX 76063
USA

Phone: +1 817 533-8130

E-mail: sales-us@poynting.tech